

DOCK® WORK PRICE LIST

Tables

Table of Contents

Price List Effective Dates:
Pricing 10.03.22
Revision 09.01.22



▶ See page

Statement of Line	DW.2
Planning	DW.3
Overview	DW.3
Technology Management	DW.4
Pricing	DW.5
Rectangular Tables	DW.5
Surface Materials	DW.6
Wood	DW.6
Laminate	DW.7
Vinyl	DW.8

Kimball®

DOCK® WORK TABLES

Statement of Line

Statement of Line	➤ See page DW.2
Planning	DW.3
Pricing	DW.5
Surface Materials	DW.6

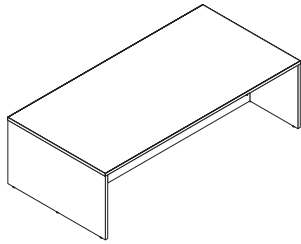

Seating-Height (29"H) Tables
➤ See page DW.5 to specify.

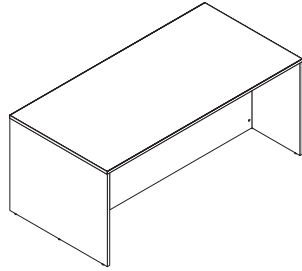

Standing-Height (41"H) Tables
➤ See page DW.5 to specify.



10" Power/Data Center
➤ See page DW.5 to specify.

DOCK® WORK TABLES

Overview

Planning

Statement of Line	➤ See page DW.2
Planning	DW.3
Pricing	DW.5
Surface Materials	DW.6

Seating-height tables are 29"H and available 78" or 96"W (nominal).

Table worksurfaces and end panels are 1³/₁₆" thick. Worksurface is 3-ply, balanced construction in wood or laminate.

Optional power/data center cut-outs are available factory installed. Upcharge applies.

Standing-height tables are 41"H and available 78" or 96"W (nominal).

Center modesty panels are 3/4" thick. They extend from the underside of the worksurface to the floor for strength and stability. It is notched at the top to accommodate a power/data center.

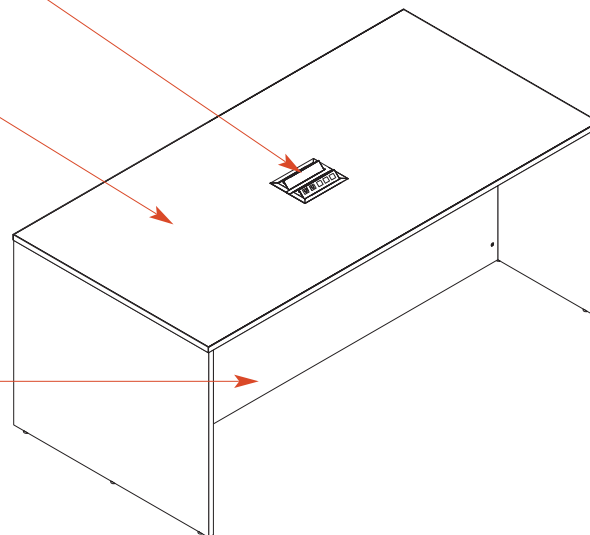
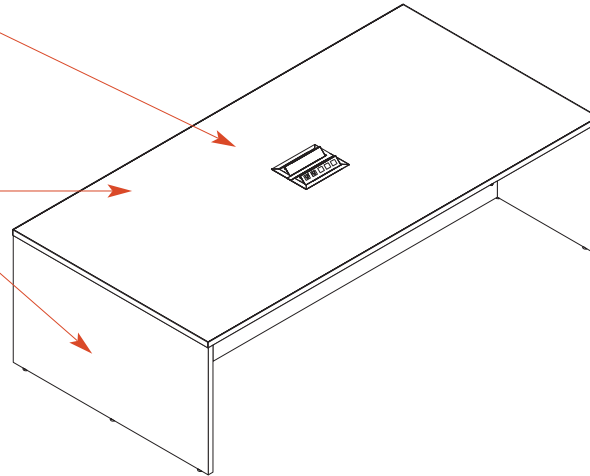

Details

Exterior surfaces are available in veneer and laminate.

Joints are securely fastened with dowels and mechanical fasteners to ensure maximum strength.

Two short modesty panels (4"H on 29"H table and 10"H for 41"H table) are included to create a trough to hide the power/data center.

Materials:

- W** Wood worksurface, rim, and chassis
- LW** High-pressure laminate (HPL) worksurface with wood rim and wood chassis
- L** High-pressure laminate (HPL) worksurface with vinyl rim and laminate chassis

Rim Profiles:

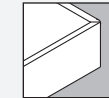

P Softened vinyl rim

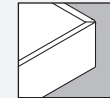

F Softened wood rim

Rim profile is 1/8" thick and appears on all edges of the worksurface. Wood and laminate with wood rim models are available with a softened wood rim. Laminate models are available with a softened vinyl rim.

DOCK® WORK TABLES

Technology Management | Power/Data Cut-Out Options

Planning

Statement of Line	➤ See page DW.2
Planning	DW.3
Pricing	DW.5
Surface Materials	DW.6

Top Size	Cut-Out Location Designators
48" x 78"	C2C = One C2 cut-out, center location
48" x 96"	C2LR = Two C2 cut-outs, both left and right end locations
	X = No cut-outs

Location of Cut-Outs

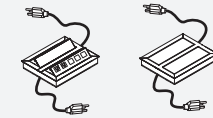
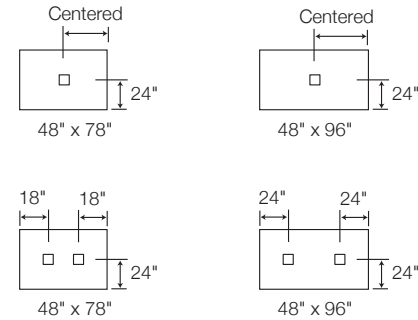

Factory-installed C2 cut-outs are sized to fit 10" power/data centers (model KCU0810ELPDC and KCU0810ELPDCH).

10" power/data center, specified separately, features two power receptacles, three blank data ports, and one 10' power cord on each side, for a total of four power receptacles, six data ports, and two power cords per unit. Voice/adapter kit is included to accept couplers and jacks when required. Top opens and closes with a touch-pivot action. Clear anodized aluminum.

How to Specify

Insert the location designator for step ④ in the table top's model number sequence.

DOCK® WORK TABLES

Rectangular

Pricing

GSA SIN 33721
† GSA Contract Pending

Statement of Line	➤ See page DW.2
Planning	DW.3
Pricing	DW.5
Surface Materials	DW.6

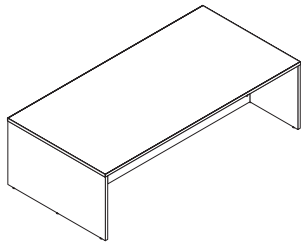

D	W	H	Model	Wood	Laminate with Wood Rim	Laminate
Seating-Height Table						
48 ¹ / ₁₆ "	77 ¹⁵ / ₁₆ "	28 ¹³ / ₁₆ "	70K487829TA	\$5842	\$5842	\$2491
	95 ⁷ / ₈ "		70K489629TA	7178	7178	2978

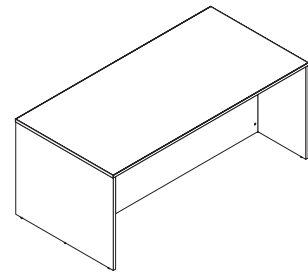

D	W	H	Model	Wood	Laminate with Wood Rim	Laminate
Standing-Height Table						
48 ¹ / ₁₆ "	77 ¹⁵ / ₁₆ "	41 ¹ / ₁₆ "	70K487841TA	\$6395	\$6395	\$2765
	95 ⁷ / ₈ "		70K489641TA	7780	7780	3360

Related Products:

D	W	H	Model	Description	Price
10" Rectangular Power/Data Center					
8"	10"	2 ¹ / ₂ "	KCU0810ELPDCPC †	For use with C2 cut-out option	\$1509
For Hardwire Application					
8"	10"	2 ¹ / ₂ "	KCU0810ELPDCHPC †	For use with C2 cut-out option	\$1585



Power/data center is for field-installation only in tops with factory-installed cutouts.

➤ See page DW.4.

U.L. listed. The customer is responsible for the proper application of products to the local codes under which installation must be made.

Standard Includes

Table

- Table
- Adjustable leveling glides
- Ships ready to assemble

10" Power/Data Center

- Four power receptacles (2 per side)
- Six blank data ports (6 per side)
- Voice/adaptor kit to accept couplers and jacks
- One touch pivot open/close
- Two 10' power cords
- Housing: silver powdercoat

How to Specify

Table

- 1 Model
- 2 Worksurface material:
L = Laminate with vinyl rim
LW = Laminate with wood rim
W = Wood with wood rim
- 3 Rim profile:
P = Softened vinyl (L models only)
F = Softened wood (LW or W models only)
- 4 Cut-out option:
➤ See page DW.4 for cut-out options (+\$74 per cut-out)
X = Without cutouts
- 5 Worksurface finish price group:
STD = Group 1
- 6 Worksurface finish designator
- 7 Rim finish price group (include for LW models only):
STD = Group 1
- 8 Rim finish designator (include for LW models only)

10" Power/Data Center

- 1 Model

DOCK® WORK TABLES

Wood

Surface Materials

Statement of Line	▶ See page DW.2
Planning	DW.3
Pricing	DW.5
Surface Materials	DW.6

Applies to:

- Dock Work tables

Group 1

MC	Amber Cherry
CC	Cordoba Cherry
MH	Mocha Cherry
SC	Sedona Cherry
IM	Brighton Maple
TM	Huntington Maple
ES	Espresso Walnut
MW	Midtown Walnut
TW	Tribeca Walnut
UW	Urban Walnut
AD	Almond Straight Grain
CO	Canyon Straight Grain
DF	Driftwood Straight Grain
YO	Monterey Straight Grain
PB	Portobello Straight Grain
792	Sable Straight Grain
NW	Tuscan Straight Grain

▶ See the *Kimball Surface Materials Reference Guide* at

www.kimball.com for a complete overview of the Kimball materials program, including:

- Characteristics of wood
- Special wood finishes
- Customer-specified laminate (CSL)
- Customer-specified paint (CSP)
- Fabric application and colorways
- Customer's own material (COM) overview
- Alliance program
- TB133 process

IMPORTANT: Wood finishes applied to solid hardwood are complementary to the same wood finish applied to wood veneer, but not an exact match.

▶ Contact Customer Service for more information.

DOCK® WORK TABLES

Laminate | HPL

Surface Materials

Statement of Line	▶ See page DW.2
Planning	DW.3
Pricing	DW.5
Surface Materials	DW.6

Applies to:

- Dock Work table tops & chassis

Woodgrain Group 1 (STD)

AD	Almond
MC	Amber
BZ	Brazilwood ¹
IM	Brighton
CO	Canyon
CI	Chai ¹
CC	Cordoba
DF	Driftwood
TM	Huntington
KN	Kona ¹
MW	Midtown
MH	Mocha
YO	Monterey
PC	Porcini ¹
PB	Portobello
792	Sable
SC	Sedona
TW	Tribeca
NW	Tuscan
UW	Urban
WL	Willow ¹

Solid Color Group 1 (STD)

480	Antique White
403	Chamois
462	Cinder
440	Cloud
457	Canyon
405	Designer White
450	Fog
488	Frosty White
461	Graphite
420	Sandstone
425	Shadow
460	Storm
419	Wallaby

Pattern Group 1 (STD)²

823	Carbon Evolv
818	Crisp Linen
841	Desert Zephyr
821	Elemental Concrete
819	Flax Gauze
862	Grey Glace
843	Misted Zephyr
807	Silcon Evolv
822	Smoke Quarstone
805	Titanium Evolv
802	White Nebula
814	White Tigris

¹ Not available on HPL surfaces with a wood rim.

² Only available on HPL surfaces with a wood rim.

Gallery Group 1 (GAL1)³

5% upcharge

G1001	Citadel
G1011	Pepperdust

Gallery Group 2 (GAL2)³

6% upcharge

G1002	Planked Raw Oak
G1003	Evening Notte
G1004	Kirsche
G1005	Midnight Run
G1006	Sepia Walnut
G1007	Serotina
G1008	Timeless
G1009	White Nebbia
G1012	Phantom Ecu

³ Gallery laminates are not available on HPL surfaces with a wood rim.

▶ See the *Kimball Surface Materials Reference Guide* at

www.kimball.com for a complete overview of the Kimball materials program, including:

- Characteristics of wood
- Special wood finishes
- Customer-specified laminate (CSL)
- Customer-specified paint (CSP)
- Fabric application and colorways
- Customer's own material (COM) overview
- Alliance program
- TB133 process

The Gallery program is an on-trend collection curated from trusted laminate suppliers.

▶ See the *Surface Materials Reference Guide* at www.kimball.com for additional program details.

DOCK® WORK TABLES

Vinyl

Surface Materials

Statement of Line	▶ See page DW.2
Planning	DW.3
Pricing	DW.5
Surface Materials	DW.6

Applies to:

- Dock Work table top rims

Woodgrain Group 1 (STD)

AD	Almond
MC	Amber
BZ	Brazilwood
IM	Brighton
CO	Canyon
CI	Chai
CC	Cordoba
DF	Driftwood
TM	Huntington
KN	Kona
MW	Midtown
MH	Mocha
YO	Monterey
PC	Porcini
PB	Portobello
792	Sable
SC	Sedona
TW	Tribeca
NW	Tuscan
UW	Urban
WL	Willow

Solid Color Group 1 (STD)

480	Antique White
403	Chamois
462	Cinder
440	Cloud
457	Dapple
485	Dark Chocolate
405	Designer White
450	Fog
488	Frosty White
461	Graphite
420	Sandstone
425	Shadow
460	Storm
419	Wallaby

Gallery Group 1 (GAL1)

5% upcharge

G1001	Citadel
G1011	Pepperdust

Gallery Group 2 (GAL2)

6% upcharge

G1002	Planked Raw Oak
G1003	Evening Notte
G1004	Kirsche
G1005	Midnight Run
G1006	Sepia Walnut
G1007	Serotina
G1008	Timeless
G1009	White Nebbia
G1012	Phantom Ecru

▶ See the *Surface Materials*

- Reference Guide* at www.kimball.com for a complete overview of the Kimball materials program, including:
- Characteristics of wood
 - Special wood finishes
 - Customer-specified laminate (CSL)
 - Customer-specified paint (CSP)
 - Fabric application and colorways
 - Customer's own material (COM) overview
 - Alliance program
 - TB133 process

IMPORTANT: Due to the reflective qualities of metallic paint, variations in color may occur.

The Gallery program is an on-trend collection curated from trusted laminate suppliers.

▶ See the *Surface Materials Reference Guide* at www.kimball.com for additional program details.