

Price List Effective Dates:
 Pricing 10.03.22
 Revisions 09.01.22



▶ See page

Statement of Line	BO.2
Planning	BO.3
Overview	BO.3
Leg Options	BO.4
Pricing	BO.5
One-Seat Lounges	BO.5
Two-Seat Lounges	BO.6
Three-Seat Lounges	BO.7
Surface Materials	BO.8
Upholstery	BO.8

Kimball®

BOYD® SEATING

Lounge

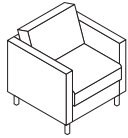

One-Seat Lounge

▶ See page BO.5 to specify.

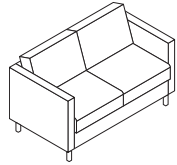

Two-Seat Lounge

▶ See page BO.5 to specify.

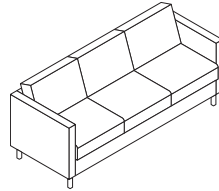

Three-Seat Lounge

▶ See page BO.5 to specify.

Statement of Line

Statement of Line	▶ See page BO.2
Planning	BO.3
Pricing	BO.5
Surface Materials	BO.8

▶ See individual pricing pages for dimensions.

BOYD® SEATING

Overview

Planning

Statement of Line	➤ See page BO.2
Planning	BO.3
Pricing	BO.5
Surface Materials	BO.8

Back cushion contains 4 $\frac{3}{4}$ "-thick high-density, high-resiliency, CFC-free, laminated polyurethane foam. Select standard cushion or sewn-tufted cushion.

Frame is constructed of plywood, utilizing lap joint construction that is glued and screwed.

6"H legs are powder-coated steel and available in three styles: square, round or Y.

➤ See page BO.4.

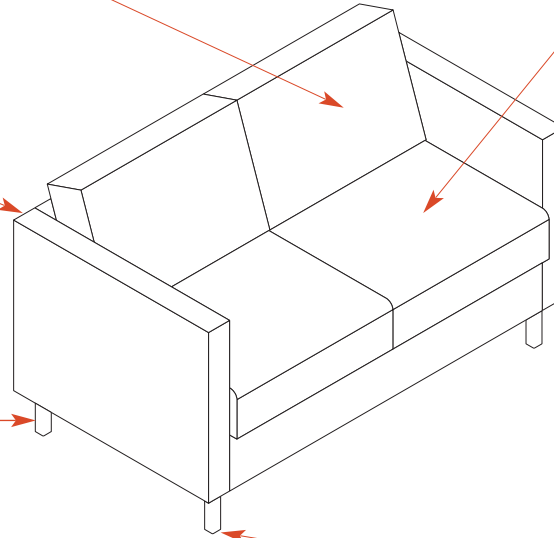

Attached seat cushion is 6"-thick thick and made of high-grade, high-resiliency, CFC-free, laminated polyurethane.

Boyd is offered in one-, two-, and three-seat lounge models. Models meet or exceed the applicable BIFMA/ANSI standards.

Leg and rail joints are double doweled, securely glued, and reinforced with corner blocks that are then glued and screwed to the base rails. The base frame is attached to the seat frame with wood screws through the rails.

Back cushions consist of high-density, high-resiliency foam over a non-stretch woven suspension that is stapled to the frame.

Seat is designed for comfort, giving you a residential feel. Wrinkles in the seat cushion are adherent to the design and should be expected.

Arms feature a sewn slipcover over top 1/2"-thick, high-grade polyurethane foam.

Non-skid, adjustable glides are 2" in diameter.

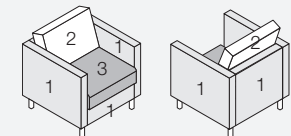

Contrasting fabric may be specified on the outer frame (1), back cushion (2), and seat cushion (3).

Accent pillows are available.

➤ See the Accent Pillow chapter in the *Kimball Seating Price List*.

BOYD® SEATING

Leg Options

Planning

Statement of Line	➤ See page BO.2
Planning	BO.3
Pricing	BO.5
Surface Materials	BO.8

Square Metal Leg:

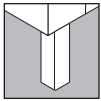

S

Finishes:

- 405** Designer White
- 462** Cinder
- 501** Platinum Metallic

Round Metal Leg:

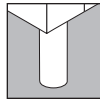

R

Finishes:

- 405** Designer White
- 462** Cinder
- 501** Platinum Metallic

Y Metal Leg:

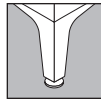

Y

Finishes:

- 462** Cinder
- 497** Polished Aluminum
- 501** Platinum Metallic

How to Specify

Specify leg option and finish together in one step.

Example:

S405 = Square metal leg in Designer White

BOYD® SEATING

One-Seat Lounges

Pricing

Statement of Line	▶ See page BO.2
Planning	BO.3
Pricing	BO.5
Surface Materials	BO.8

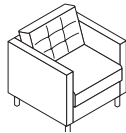

Sewn-Tufted Back Cushion

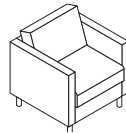

Standard Back Cushion

Model	Description	In-Line Upholstery Pricing									Shipping		GSA
		1	2/COM	3/COL	4	5	6	7	L7	L8	lbs.	Cubic Feet	SIN
K741AT	Sewn-tufted back cushion	\$2577	2862	3022	3210	3478	3747	4008	5131	5758	94.00	22.30	33721
K741A	Standard back cushion	\$2242	2527	2687	2875	3143	3412	3673	4796	5423	94.00	22.30	33721

Model	Alliance Program Upholstery Pricing																	
	A	B	C	D	E	F	G	H	I	J	K	L	M	N	O	P	Q	R
K741AT	\$2993	3193	3348	3506	3677	3877	3991	4207	4390	4578	4880	5478	5860	5946	6020	6111	6202	6624
K741A	\$2658	2858	3013	3171	3342	3542	3656	3872	4055	4243	4545	5143	5525	5611	5685	5776	5867	6289

Description	Dimensions (Inches)							COM (Yards)				COL	
	Overall			Seat			Arm	1-4"			5-11"	12-18"	Sq.
	H	W	D	H	W	D	H	Non-Dir.	Repeat	Repeat	Repeat	Feet	
Sewn-tufted cushion	32	28½	30	19	22½	19	26½	Entire Unit	4.5	6.2	7.5	7.8	90.0
								Back	0.9	1.4	1.7	2.2	18.0
								Seat	1.1	1.2	1.5	1.8	22.0
								Frame	3.7	4.3	5.0	5.0	74.0
Standard back cushion	32	28½	30	19	22½	19	26½	Entire Unit	4.1	5.8	7.5	7.4	82.0
								Back	0.9	1.0	1.7	2.2	18.0
								Seat	1.1	1.2	1.5	1.8	22.0
								Frame	3.7	4.3	5.0	5.0	74.0

Tips

IMPORTANT: Orders cannot be cancelled for chairs specified with Alliance Program upholstery.

When specifying a striped or directional textile, a solid pattern is recommended for the back cushion due to alignment constraints.

Contrasting fabric is available. Use an electronic specification tool for accurate pricing

Models that meet TB133 requirements are available in select upholstery.

▶ Contact **By Design**.

How to Specify

1 Model

- Frame (primary):
- 2 Upholstery grade or Alliance prefix + upholstery grade
- 3 Upholstery number

Back Cushion:

- 4 Upholstery grade or Alliance prefix + upholstery grade
- 5 Upholstery number

Seat Cushion:

- 6 Upholstery grade or Alliance prefix + upholstery grade
- 7 Upholstery number

8 Leg option:

- ▶ See page BO.4 for designators.

BOYD® SEATING

Two-Seat Lounges

Pricing

Statement of Line	▶ See page BO.2
Planning	BO.3
Pricing	BO.5
Surface Materials	BO.8

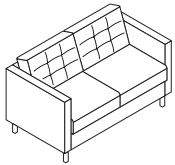

Sewn-Tufted Back Cushion

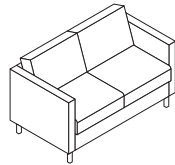

Standard Back Cushion

Model	Description	In-Line Upholstery Pricing									Shipping		GSA
		1	2/COM	3/COL	4	5	6	7	L7	L8	lbs.	Cubic Feet	SIN
K742AT	Sewn-tufted back cushion	\$3830	4180	4376	4608	4936	5266	5588	6966	7736	145.00	37.90	33721
K742A	Standard back cushion	\$3161	3511	3707	3939	4267	4597	4919	6297	7067	145.00	37.90	33721

Model	Alliance Program Upholstery Pricing																	
	A	B	C	D	E	F	G	H	I	J	K	L	M	N	O	P	Q	R
K742AT	\$4342	4586	4776	4972	5182	5426	5566	5832	6056	6288	6658	7394	5860	7968	8058	8170	8282	8800
K742A	\$3673	3917	4107	4303	4513	4757	4897	5163	5387	5619	5989	6725	7193	7299	7389	7501	7613	8131

Description	Dimensions (Inches)							COM (Yards)				COL	
	Overall			Seat			Arm	1-4"		5-11"	12-18"	Sq.	
	H	W	D	H	W	D	H	Non-Dir.	Repeat	Repeat	Repeat	Feet	
Sewn-tufted cushion	32	51	30	19	45	19	26½	Entire Unit	6.1	9.4	11.1	12.2	121.5
								Back	1.5	2.4	3.3	4.2	30.0
								Seat	1.5	2.2	3.0	3.8	30.0
								Frame	4.0	5.4	6.3	6.0	80.0
Standard back cushion	32	51	30	19	45	19	26½	Entire Unit	6.0	8.9	11.1	12.2	119.5
								Back	1.5	1.8	3.3	4.2	30.0
								Seat	1.5	2.2	3.0	3.8	30.0
								Frame	4.0	5.4	6.3	6.0	80.0

Tips

IMPORTANT: Orders cannot be cancelled for chairs specified with Alliance Program upholstery.

When specifying a striped or directional textile, a solid pattern is recommended for the back cushion due to alignment constraints.

Contrasting fabric is available. Use an electronic specification tool for accurate pricing

Models that meet TB133 requirements are available in select upholstery.

▶ Contact **By Design**.

How to Specify

① Model

- Frame (primary):
- ② Upholstery grade or Alliance prefix + upholstery grade
- ③ Upholstery number

Back Cushion:

- ④ Upholstery grade or Alliance prefix + upholstery grade
- ⑤ Upholstery number

Seat Cushion:

- ⑥ Upholstery grade or Alliance prefix + upholstery grade
- ⑦ Upholstery number

⑧ Leg option:

▶ See page BO.4 for designators.

BOYD® SEATING

Three-Seat Lounges

Pricing

Statement of Line	▶ See page BO.2
Planning	BO.3
Pricing	BO.5
Surface Materials	BO.8

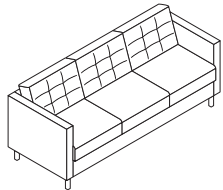

Sewn-Tufted Back Cushion

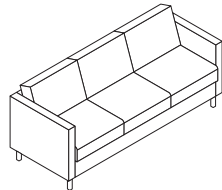

Standard Back Cushion

Model	Description	In-Line Upholstery Pricing									Shipping		GSA
		1	2/COM	3/COL	4	5	6	7	L7	L8	lbs.	Cubic Feet	SIN
K743AT	Sewn-tufted back cushion	\$5337	5807	6069	6380	6821	7265	7696	9547	10581	196.00	52.30	33721
K743A	Standard back cushion	\$4497	4967	5229	5540	5981	6425	6856	8707	9741	196.00	52.30	33721

Model	Alliance Program Upholstery Pricing																	
	A	B	C	D	E	F	G	H	I	J	K	L	M	N	O	P	Q	R
K743AT	\$6023	6351	6607	6869	7151	7479	7667	8026	8325	8636	9134	10122	10752	10892	11014	11165	11316	12011
K743A	\$5183	5511	5767	6029	6311	6639	6827	7186	7485	7796	8294	9282	9912	10052	10174	10325	10476	11171

Description	Dimensions (Inches)							COM (Yards)				COL	
	Overall			Seat			Arm	1-4"		5-11"	12-18"	Sq.	
	H	W	D	H	W	D	H	Non-Dir.	Repeat	Repeat	Repeat	Feet	
Sewn-tufted cushion	32	73½	30	19	67½	19	26½	Entire Unit	8.2	12.7	15.2	17.2	163.5
								Back	2.3	3.8	4.8	6.2	46.0
								Seat	2.3	3.2	4.6	5.8	46.0
								Frame	4.8	6.6	7.5	7.0	96.0
Standard back cushion	32	73½	30	19	67½	19	26½	Entire Unit	7.8	11.4	15.2	17.2	155.5
								Back	2.3	2.8	4.8	6.2	46.0
								Seat	2.3	3.2	4.6	5.8	46.0
								Frame	4.8	6.6	7.5	7.0	96.0

Tips

IMPORTANT: Orders cannot be cancelled for chairs specified with Alliance Program upholstery.

When specifying a striped or directional textile, a solid pattern is recommended for the back cushion due to alignment constraints.

Contrasting fabric is available. Use an electronic specification tool for accurate pricing

Models that meet TB133 requirements are available in select upholstery.

▶ Contact **By Design**.

How to Specify

- ① Model
 - Frame (primary):
- ② Upholstery grade or Alliance prefix + upholstery grade
- ③ Upholstery number
 - Back Cushion:
- ④ Upholstery grade or Alliance prefix + upholstery grade
- ⑤ Upholstery number
 - Seat Cushion:
- ⑥ Upholstery grade or Alliance prefix + upholstery grade
- ⑦ Upholstery number
- ⑧ Leg option:
 - ▶ See page BO.4 for designators.

Statement of Line	▶ See page BO.2
Planning	BO.3
Pricing	BO.5
Surface Materials	BO.8

Applies to:

- Boyd seating

Kimball Seating Fabric

Price Grades 1–7

▶ See the *Surface Materials Reference Guide* at www.kimball.com for the most up-to-date list of available seating fabric patterns.

Kimball Leather

Price Grades L7 and L8

▶ See the *Surface Materials Reference Guide* at www.kimball.com for the most up-to-date list of available seating leather.

Alliance Fabric

Price Grades A–R

▶ See Surface Materials at www.kimball.com for a wide variety of graded-in fabrics from Arc-Com, Carnegie, CF Stinson, Maharam, Mayer Fabrics, Momentum, and Ultrafabrics.

COM/COL

Kimball has analyzed each model to most accurately reflect the COM/COL yardage requirements shown on the pricing pages. The yardage requirement for each model is based on 54"W fabric and cutting the fabric up the roll.

For widths other than 54", increase the yardage requirement by the factors below:

<i>Fabric width</i>	<i>Increase yardage</i>
50"–53"	15%
48"–49"	30%
45"–47"	45%

If repeat is larger than 18", contact Customer Service to confirm the correct amount of yardage required.

When ordering 10 or more chairs in the same COM, yardage requirements may be reduced.

▶ Contact Customer Service.

- ▶ See the *Kimball Surface Materials Reference Guide* at www.kimball.com for a complete overview of the Kimball materials program, including:
- Characteristics of wood
 - Special wood finishes
 - Customer-specified laminate (CSL)
 - Customer-specified paint (CSP)
 - Fabric application and colorways
 - Customer's own material (COM) process overview
 - Alliance program
 - TB133 process