

<b>Price List Effective Dates:</b>	
Pricing	03.01.22
Revision	05.16.22



▶ See page

<b>Statement of Line</b>	BO.2
<b>Planning</b>	BO.3
Overview	BO.3
Leg Options	BO.4
<b>Pricing</b>	BO.5
One-Seat Lounges	BO.5
Two-Seat Lounges	BO.6
Three-Seat Lounges	BO.7
<b>Surface Materials</b>	BO.8
Upholstery	BO.8

# BOYD® SEATING

## Lounge

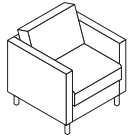

### One-Seat Lounge

▶ See page BO.5 to specify.

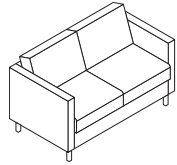

### Two-Seat Lounge

▶ See page BO.5 to specify.

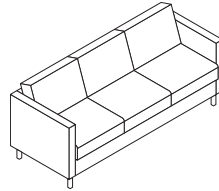

### Three-Seat Lounge

▶ See page BO.5 to specify.

## Statement of Line

Statement of Line	▶ See page BO.2
Planning	BO.3
Pricing	BO.5
Surface Materials	BO.8

▶ See individual pricing pages for dimensions.

# BOYD® SEATING

## Overview

## Planning

Statement of Line	➤ See page BO.2
Planning	BO.3
Pricing	BO.5
Surface Materials	BO.8

**Back cushion** contains 4 $\frac{3}{4}$ "-thick high-density, high-resiliency, CFC-free, laminated polyurethane foam. Select standard cushion or sewn-tufted cushion.

**Frame** is constructed of plywood, utilizing lap joint construction that is glued and screwed.

**6"H legs** are powder-coated steel and available in three styles: square, round or Y.

➤ See page BO.4.

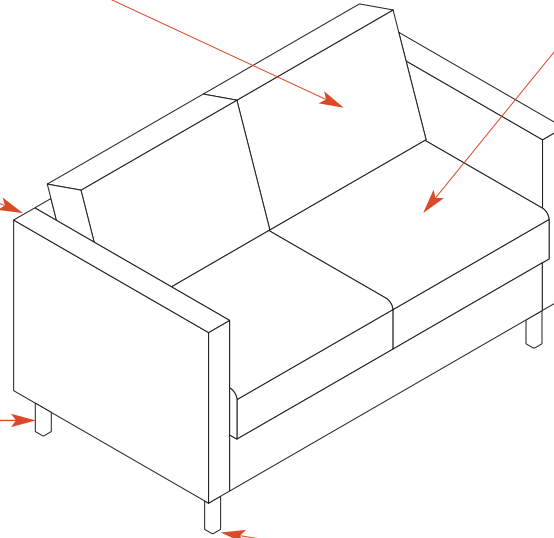

**Attached seat cushion** is 6"-thick thick and made of high-grade, high-resiliency, CFC-free, laminated polyurethane.

**Non-skid, adjustable glides** are 2" in diameter.

**Boyd** is offered in one-, two-, and three-seat lounge models. Models meet or exceed the applicable BIFMA/ANSI standards.

**Leg and rail joints** are double doweled, securely glued, and reinforced with corner blocks that are then glued and screwed to the base rails. The base frame is attached to the seat frame with wood screws through the rails.

**Back cushions** consist of high-density, high-resiliency foam over a non-stretch woven suspension that is stapled to the frame.

**Seat** is designed for comfort, giving you a residential feel. Wrinkles in the seat cushion are adherent to the design and should be expected.

**Arms** feature a sewn slipcover over top 1/2"-thick, high-grade polyurethane foam.

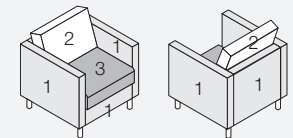

**Contrasting fabric** may be specified on the outer frame (1), back cushion (2), and seat cushion (3).

**Accent pillows** are available.

➤ See the Accent Pillow chapter in the *Kimball Seating Price List*.

# BOYD® SEATING

## Leg Options

## Planning

Statement of Line	➤ See page BO.2
Planning	BO.3
Pricing	BO.5
Surface Materials	BO.8

### Square Metal Leg:

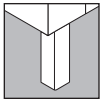

**S**

**Finishes:**

- 405** Designer White
- 462** Cinder
- 501** Platinum Metallic

### Round Metal Leg:

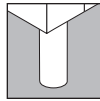

**R**

**Finishes:**

- 405** Designer White
- 462** Cinder
- 501** Platinum Metallic

### Y Metal Leg:

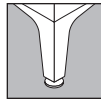

**Y**

**Finishes:**

- 462** Cinder
- 497** Polished Aluminum
- 501** Platinum Metallic

### How to Specify

**Specify leg option and finish together** in one step.

Example:

**S405** = Square metal leg in Designer White

# BOYD® SEATING

## One-Seat Lounges

## Pricing

Statement of Line	▶ See page BO.2
Planning	BO.3
Pricing	BO.5
Surface Materials	BO.8

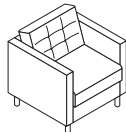

Sewn-Tufted Back Cushion

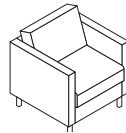

Standard Back Cushion

Model	Description	In-Line Upholstery Pricing									Shipping		GSA
		1	2/COM	3/COL	4	5	6	7	L7	L8	lbs.	Cubic Feet	SIN
K741AT	Sewn-tufted back cushion	\$2343	2601	2748	2919	3164	3403	3643	4663	5233	94.00	22.30	33721
K741A	Standard back cushion	\$2038	2296	2443	2614	2859	3098	3338	4358	4928	94.00	22.30	33721

Model	Alliance Program Upholstery Pricing																	
	A	B	C	D	E	F	G	H	I	J	K	L	M	N	O	P	Q	R
K741AT	\$2719	2902	3044	3187	3342	3523	3627	3825	3990	4161	4435	4982	5330	5404	5472	5558	5638	6021
K741A	\$2414	2597	2739	2882	3037	3218	3322	3520	3685	3856	4130	4677	5025	5099	5167	5253	5333	5716

Description	Dimensions (Inches)							COM (Yards)				COL	
	Overall			Seat			Arm	1-4"			5-11"	12-18"	Sq.
	H	W	D	H	W	D	H	Non-Dir.	Repeat	Repeat	Repeat	Feet	
Sewn-tufted cushion	32	28½	30	19	22½	19	26½	Entire Unit	4.5	6.2	7.5	7.8	90.0
								Back	0.9	1.4	1.7	2.2	18.0
								Seat	1.1	1.2	1.5	1.8	22.0
								Frame	3.7	4.3	5.0	5.0	74.0
Standard back cushion	32	28½	30	19	22½	19	26½	Entire Unit	4.1	5.8	7.5	7.4	82.0
								Back	0.9	1.0	1.7	2.2	18.0
								Seat	1.1	1.2	1.5	1.8	22.0
								Frame	3.7	4.3	5.0	5.0	74.0

### Tips

IMPORTANT: Orders cannot be cancelled for chairs specified with Alliance Program upholstery.

When specifying a striped or directional textile, a solid pattern is recommended for the back cushion due to alignment constraints.

Contrasting fabric is available. Use an electronic specification tool for accurate pricing

Models that meet TB133 requirements are available in select upholstery.

▶ Contact **By Design**.

### How to Specify

#### 1 Model

- Frame (primary):
- 2 Upholstery grade or Alliance prefix + upholstery grade
- 3 Upholstery number

#### Back Cushion:

- 4 Upholstery grade or Alliance prefix + upholstery grade
- 5 Upholstery number

#### Seat Cushion:

- 6 Upholstery grade or Alliance prefix + upholstery grade
- 7 Upholstery number

#### 8 Leg option:

- ▶ See page BO.4 for designators.

# BOYD® SEATING

## Two-Seat Lounges

### Pricing

Statement of Line	▶ See page BO.2
Planning	BO.3
Pricing	BO.5
Surface Materials	BO.8

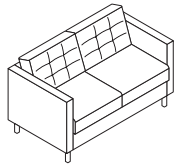

**Sewn-Tufted Back Cushion**

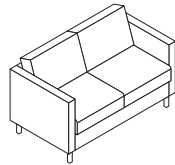

**Standard Back Cushion**

Model	Description	In-Line Upholstery Pricing									Shipping		GSA
		1	2/COM	3/COL	4	5	6	7	L7	L8	lbs.	Cubic Feet	SIN
<b>K742AT</b>	Sewn-tufted back cushion	\$3482	3798	3980	4190	4490	4784	5078	6332	7032	145.00	37.90	33721
<b>K742A</b>	Standard back cushion	\$2874	3190	3372	3582	3882	4176	4470	5724	6424	145.00	37.90	33721

Model	Alliance Program Upholstery Pricing																	
	A	B	C	D	E	F	G	H	I	J	K	L	M	N	O	P	Q	R
<b>K742AT</b>	\$3944	4168	4344	4518	4708	4932	5058	5302	5506	5716	6052	6724	5330	7242	7326	7430	7528	7998
<b>K742A</b>	\$3336	3560	3736	3910	4100	4324	4450	4694	4898	5108	5444	6116	6542	6634	6718	6822	6920	7390

Description	Dimensions (Inches)							COM (Yards)				COL	
	Overall			Seat			Arm	1-4"		5-11"	12-18"	Sq.	
	H	W	D	H	W	D	H	Non-Dir.	Repeat	Repeat	Repeat	Feet	
Sewn-tufted cushion	32	51	30	19	45	19	26½	Entire Unit	6.1	9.4	11.1	12.2	121.5
								Back	1.5	2.4	3.3	4.2	30.0
								Seat	1.5	2.2	3.0	3.8	30.0
								Frame	4.0	5.4	6.3	6.0	80.0
Standard back cushion	32	51	30	19	45	19	26½	Entire Unit	6.0	8.9	11.1	12.2	119.5
								Back	1.5	1.8	3.3	4.2	30.0
								Seat	1.5	2.2	3.0	3.8	30.0
								Frame	4.0	5.4	6.3	6.0	80.0

### Tips

**IMPORTANT:** Orders cannot be cancelled for chairs specified with Alliance Program upholstery.

When specifying a striped or directional textile, a solid pattern is recommended for the back cushion due to alignment constraints.

Contrasting fabric is available. Use an electronic specification tool for accurate pricing

Models that meet TB133 requirements are available in select upholstery.

▶ Contact **By Design**.

### How to Specify

- ① Model
  - Frame (primary):
- ② Upholstery grade or Alliance prefix + upholstery grade
- ③ Upholstery number
  - Back Cushion:
- ④ Upholstery grade or Alliance prefix + upholstery grade
- ⑤ Upholstery number
  - Seat Cushion:
- ⑥ Upholstery grade or Alliance prefix + upholstery grade
- ⑦ Upholstery number
- ⑧ Leg option:
  - ▶ See page BO.4 for designators.

# BOYD® SEATING

## Three-Seat Lounges

### Pricing

Statement of Line	▶ See page BO.2
Planning	BO.3
Pricing	BO.5
Surface Materials	BO.8

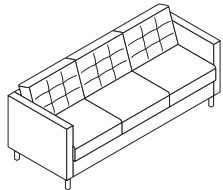

**Sewn-Tufted Back Cushion**

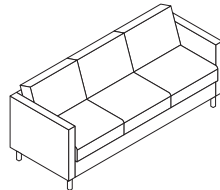

**Standard Back Cushion**

Model	Description	In-Line Upholstery Pricing									Shipping		GSA
		1	2/COM	3/COL	4	5	6	7	L7	L8	lbs.	Cubic Feet	SIN
<b>K743AT</b>	Sewn-tufted back cushion	\$4852	5276	5519	5801	6205	6601	6994	8678	9618	196.00	52.30	33721
<b>K743A</b>	Standard back cushion	\$4088	4512	4755	5037	5441	5837	6230	7914	8854	196.00	52.30	33721

Model	Alliance Program Upholstery Pricing																	
	A	B	C	D	E	F	G	H	I	J	K	L	M	N	O	P	Q	R
<b>K743AT</b>	\$5473	5772	6008	6242	6498	6798	6968	7296	7569	7851	8302	9204	9777	9900	10013	10153	10284	10916
<b>K743A</b>	\$4709	5008	5244	5478	5734	6034	6204	6532	6805	7087	7538	8440	9013	9136	9249	9389	9520	10152

Description	Dimensions (Inches)							COM (Yards)				COL	
	Overall			Seat			Arm	1-4"			5-11"	12-18"	Sq.
	H	W	D	H	W	D	H	Non-Dir.	Repeat	Repeat	Repeat	Feet	
Sewn-tufted cushion	32	73½	30	19	67½	19	26½	Entire Unit	8.2	12.7	15.2	17.2	163.5
								Back	2.3	3.8	4.8	6.2	46.0
								Seat	2.3	3.2	4.6	5.8	46.0
								Frame	4.8	6.6	7.5	7.0	96.0
Standard back cushion	32	73½	30	19	67½	19	26½	Entire Unit	7.8	11.4	15.2	17.2	155.5
								Back	2.3	2.8	4.8	6.2	46.0
								Seat	2.3	3.2	4.6	5.8	46.0
								Frame	4.8	6.6	7.5	7.0	96.0

### Tips

IMPORTANT: Orders cannot be cancelled for chairs specified with Alliance Program upholstery.

When specifying a striped or directional textile, a solid pattern is recommended for the back cushion due to alignment constraints.

Contrasting fabric is available. Use an electronic specification tool for accurate pricing

Models that meet TB133 requirements are available in select upholstery.

▶ Contact **By Design**.

### How to Specify

- ① Model
  - Frame (primary):
- ② Upholstery grade or Alliance prefix + upholstery grade
- ③ Upholstery number
  - Back Cushion:
- ④ Upholstery grade or Alliance prefix + upholstery grade
- ⑤ Upholstery number
  - Seat Cushion:
- ⑥ Upholstery grade or Alliance prefix + upholstery grade
- ⑦ Upholstery number
- ⑧ Leg option:
  - ▶ See page BO.4 for designators.

Statement of Line	▶ See page BO.2
Planning	BO.3
Pricing	BO.5
Surface Materials	BO.8

*Applies to:*

- Boyd seating

**Kimball Seating Fabric**

Price Grades 1–7

▶ See the *Surface Materials Reference Guide* at [www.kimball.com](http://www.kimball.com) for the most up-to-date list of available seating fabric patterns.

**Kimball Leather**

Price Grades L7 and L8

▶ See the *Surface Materials Reference Guide* at [www.kimball.com](http://www.kimball.com) for the most up-to-date list of available seating leather.

**Alliance Fabric**

Price Grades A–R

▶ See Surface Materials at [www.kimball.com](http://www.kimball.com) for a wide variety of graded-in fabrics from Arc-Com, Carnegie, CF Stinson, Maharam, Mayer Fabrics, Momentum, and Ultrafabrics.

**COM/COL**

Kimball has analyzed each model to most accurately reflect the COM/COL yardage requirements shown on the pricing pages. The yardage requirement for each model is based on 54"W fabric and cutting the fabric up the roll.

For widths other than 54", increase the yardage requirement by the factors below:

<i>Fabric width</i>	<i>Increase yardage</i>
50"–53"	15%
48"–49"	30%
45"–47"	45%

If repeat is larger than 18", contact Customer Service to confirm the correct amount of yardage required.

When ordering 10 or more chairs in the same COM, yardage requirements may be reduced.

▶ Contact Customer Service.

- ▶ See the *Kimball Surface Materials Reference Guide* at [www.kimball.com](http://www.kimball.com) for a complete overview of the Kimball materials program, including:
- Characteristics of wood
  - Special wood finishes
  - Customer-specified laminate (CSL)
  - Customer-specified paint (CSP)
  - Fabric application and colorways
  - Customer's own material (COM) process overview
  - Alliance program
  - TB133 process