

<b>PRICE LIST EFFECTIVE DATES:</b>	
Pricing	10.01.21
Revision	10.11.21



▶ See page

<b>Statement of Line</b>	PD.2
<b>Planning</b>	PD.3
A-Frame Mobile Screens	PD.3
Suspension Rods & Panels	PD.4
<b>Pricing</b>	PD.5
A-Frame Mobile Screens	PD.5
Suspension Rods & Panels	PD.6
<b>Surface Materials</b>	PD.7
Wood Finishes	PD.7
Fabric & Leather	PD.8
Paint	PD.9

# PARADOLIA™ SCREENS & SUSPENSION PANELS

## Statement of Line

Statement of Line	➤ See page PD.2
Planning	PD.3
Pricing	PD.5
Surface Materials	PD.7

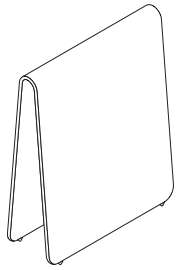

**A-Frame Mobile Screens**

➤ See page PD.5 to specify.

	57"H	71"H
46"W	●	●

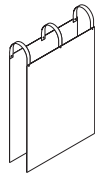

**Dual-Sided Markerboard Saddle**

➤ See page PD.5 to specify.

	34"H
25"W	●



**Magnetic Marker/Eraser Holder**

➤ See page PD.5 to specify.

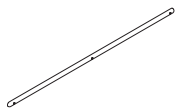

**Suspension Rods**

➤ See page PD.6 to specify.

	1"H
30"W	●
61"W	●
93"W	●

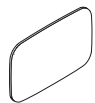

**Suspension Panels**

➤ See page PD.6 to specify.

	19"H
29"W	●

IMPORTANT: All dimensions shown in the Statement of Line are nominal and have been rounded to the nearest inch. Refer the appropriate pricing pages for actual dimensions.

# PARADOLIA™ SCREENS & SUSPENSION PANELS

## A-Frame Mobile Screens

Planning

Statement of Line	➤ See page PD.2
Planning	PD.3
Pricing	PD.5
Surface Materials	PD.7

**A-Frame mobile screens** provide space division or create impromptu gathering spaces.

**Medium A-frame mobile screen** is 46"W x 57"H with a tackable fabric surface. Medium screen can nest inside a large screen for optimal storage when not in use.

**Screens** are available in two fabric selections:

- Blazer Lite Retreat (grade 2)
- Blazer Lite Solace (grade 2)

COM is not available.

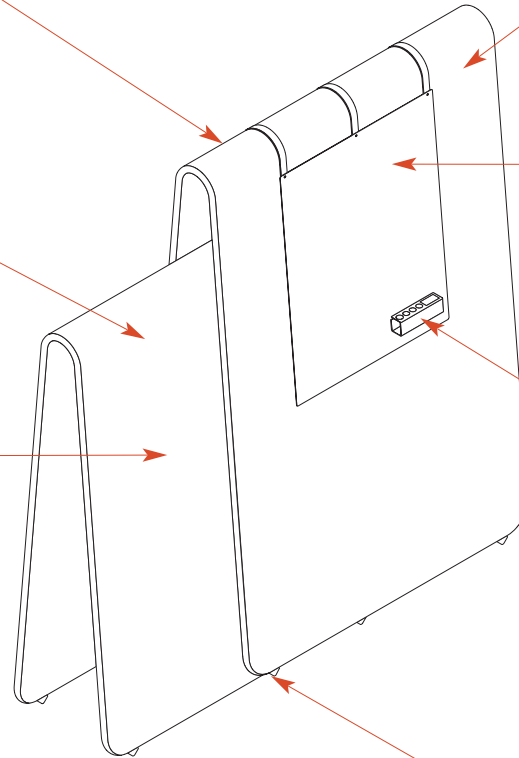

**Large A-frame mobile screen** is 46"W x 71"H with a tackable fabric surface.

**Dual-sided, magnetic marker-board saddle**, specified separately, provides two 18-gauge metal, white writing surfaces, one for each side of the A-frame mobile screen. Three 10<sup>5</sup>/<sub>8</sub>"-long leather straps—available in Camel, Chestnut or Ebony—suspend the markerboard over the A-frame mobile screen.

**KORE™ magnetic marker/eraser holder**, specified separately, keeps markers and erasers close by. Holder accommodates four markers and one eraser.

**Four, non-locking casters** are standard on each mobile screen.

**IMPORTANT:** Expo dry-erase markers are recommended for use on markerboards. All other markers are not recommended, as they may leave undesirable results when erased.

### Acoustic Rating:

A-Frame Mobile Screens  
NRC = .9

# PARADOLIA™ SCREENS & SUSPENSION PANELS

## Suspension Rods & Panels

Planning

Statement of Line	➤ See page PD.2
Planning	PD.3
Pricing	PD.5
Surface Materials	PD.7

**Suspension rods and panels** are both decorative and functional. Panel surface is tackable fabric.

**Suspension rods** are made of birch wood and available in a variety of finishes. They are available in three sizes.

**Acoustic Rating:**  
Suspension Panels and Rod  
NRC = .8

**Large (93"W) suspension rod** supports two or three suspension panels and comes standard with six leather straps.

**Pre-drilled pilot holes on front of suspension rod** are standard for attachment of rod to a wall. **IMPORTANT:** Selection and purchase of the proper attachment fasteners for the wall conditions is the responsibility of the installer.

**Medium (61"W) suspension rod** supports two suspension panels and comes standard with four leather straps.

**Suspension panels**, specified separately, are 29½"W x 19"H. Panels are available in four fabric selections:

- Cara Shetland (grade 1)
- Cara Merrick (grade 1)
- Blazer Lite Retreat (grade 2)
- Blazer Lite Solace (grade 2)

COM is not available.

**Small (30"W) suspension rod** supports one suspension panel and comes standard with two leather straps.

**Leather straps** are available in Camel, Chestnut or Ebony; they ship standard with the rod to suspend a suspension panel.

# PARADOLIA™ SCREENS & SUSPENSION PANELS

## A-Frame Mobile Screens & Accessories

Pricing

Statement of Line	➤ See page PD.2
Planning	PD.3
Pricing	PD.5
Surface Materials	PD.7

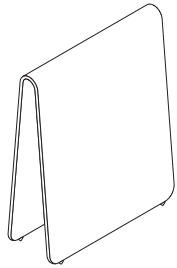

Medium A-Frame

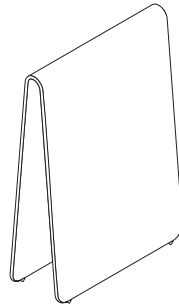

Large A-Frame

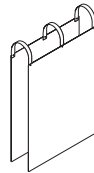

Dual-Sided Markerboard Saddle



KORE™ Magnetic Marker/Eraser Holder

Model	Description	Dimensions (Inches)			Price	Shipping		GSA
		D	W	H		lbs.	Cubic Feet	
<b>MOBILE SCREENS</b>								
<b>26K4657AFSCMF</b>	Medium A-Frame	14 <sup>7</sup> / <sub>8</sub>	46 <sup>7</sup> / <sub>16</sub>	57 <sup>1</sup> / <sub>16</sub>	\$5890	88.00	30.40	Pending
<b>26K4670AFSCMF</b>	Large A-Frame	17 <sup>5</sup> / <sub>16</sub>	46 <sup>7</sup> / <sub>16</sub>	70 <sup>7</sup> / <sub>8</sub>	\$7121	106.00	42.60	Pending
<b>ACCESSORIES</b>								
<b>26K2538MBS2</b>	Markerboard Saddle	1 <sup>1</sup> / <sub>8</sub>	25	34 <sup>1</sup> / <sub>16</sub>	\$501	33.00	2.70	Pending
<b>25KMMHP</b>	Marker/Eraser Holder	1 <sup>3</sup> / <sub>4</sub>	3 <sup>1</sup> / <sub>8</sub>	3 <sup>1</sup> / <sub>2</sub>	\$194	2.00	0.50	33721

### Standard Includes

#### A-Frame Screen

- 4 non-locking casters
- Matching piping

#### Markerboard Saddle

- Two metal, magnetic markerboards
- Three 10<sup>5</sup>/<sub>8</sub>"-long leather straps

#### Marker/Eraser Holder

- Holds four markers and one eraser: paint

### Tips

Expo dry-erase markers are recommended for use on markerboards. All other markers are not recommended, as they may leave undesirable results when erased.

### How to Specify

#### A-Frame Screens

- Model
- Fabric designator:  
**221** = Blazer Lite Retreat  
**222** = Blazer Lite Solace

#### Markerboard Saddle

- Model
- Leather designator:  
**EBONY** = Black leather  
**CHESTNUT** = Medium brown leather  
**CAMEL** = Light brown leather

#### Marker/Eraser Holder

- Model
- Paint group:  
**STD** = Group 1  
**STD M** = Group M (+10%)  
**STD 21** = Group 21 (+10%)
- Paint designator

# PARADOLIA™ SCREENS & SUSPENSION PANELS

## Suspension Rods & Panels

Pricing



### Small Suspension Rod

- Two leather straps

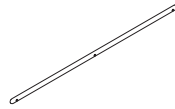

### Medium Suspension Rod

- Four leather straps

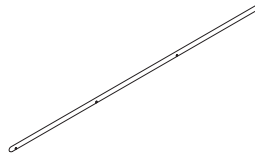

### Large Suspension Rod

- Six leather straps



### Suspension Panel

Model	Description	Dimensions (Inches)			Price	Shipping		GSA
		D	W	H		lbs.	Cubic Feet	
<b>SUSPENSION RODS</b>								
26K30SURD1W	Small Rod	13/16	29 1/2	17/16	\$432	2.10	0.20	Pending
26K61SURD2W	Medium Rod	13/16	61	17/16	\$755	3.20	2.70	Pending
26K92SURD3W	Large Rod	13/16	92 1/2	17/16	\$1066	4.30	0.40	Pending

Model	Description	Dimensions (Inches)			Price	Shipping		GSA
		D	W	H		lbs.	Cubic Feet	
<b>SUSPENSION PANEL</b>								
26K3019SUPNF	Suspension panel	17/16	29 1/2	18 7/8	\$876	11.60	1.30	Pending

Statement of Line	▶ See page PD.2
Planning	PD.3
Pricing	PD.5
Surface Materials	PD.7

### Standard Includes

#### Suspension Rods

- Birch wood rod
- Pre-drilled pilot holes for wall attachment hardware (not included)
- Leather straps
- Hardware for leather straps

#### Suspension Panel

- Fabric acoustic panel

### Tips

Selection and purchase of the proper attachment fasteners for the wall conditions is the responsibility of the installer.

### How to Specify

#### Suspension Rod

- Model
- Wood price group:  
**STD** = Group 1
- Wood finish designator
- Leather designator:  
**EBONY** = Black leather  
**CHESTNUT** = Medium brown leather  
**CAMEL** = Light brown leather

#### Suspension Panel

- Model
- Fabric designator:  
**133** = Cara Shetland (grade 1)  
**134** = Cara Merrick (grade 1)  
**221** = Blazer Lite Retreat (grade 2 +3%)  
**222** = Blazer Lite Solace (grade 2 +3%)

# PARADOLIA™ SCREENS & SUSPENSION PANELS

## Wood Finishes

## Surface Materials

Statement of Line	▶ See page PD.2
Planning	PD.3
Pricing	PD.5
Surface Materials	PD.7

*Applies to:*

- Paradolia suspension rods

**Price Group 1**

AD	Almond
MC	Amber
IM	Brighton
CO	Canyon
CC	Cordoba
DF	Driftwood
ES	Espresso
TM	Huntington
MW	Midtown
MH	Mocha
YO	Monterey
PB	Portobello
792	Sable
SC	Sedona
TW	Tribeca
NW	Tuscan
UW	Urban

▶ See the *Surface Materials*

*Reference Guide* at

www.kimball.com for a complete overview of the Kimball materials program, including:

- Characteristics of wood
- Special wood finishes
- Customer-specified laminate (CSL)
- Customer-specified paint (CSP)
- Fabric application and colorways
- Customer's own material (COM) overview
- Alliance program
- TB133 process

IMPORTANT: Wood finishes applied to solid hardwood are complementary to the same wood finish applied to wood veneer, but not an exact match.

▶ Contact Customer Service for more information.

Statement of Line	▶ See page PD.2
Planning	PD.3
Pricing	PD.5
Surface Materials	PD.7

**Fabric**

*Applies to:*

- A-frame mobile screens

**Blazer Lite**

Price Grade: **2**

221	Retreat
222	Solace

*Applies to:*

- Suspension panels

**Cara**

Price Grade: **1**

133	Shetland
134	Merrick

**Blazer Lite**

Price Grade: **2**

3% upcharge

221	Retreat
222	Solace

**Leather**

*Applies to:*

- Markerboard saddle straps
- Suspension rod straps

EBONY	Black
CHESTNUT	Medium Brown
CAMEL	Light Brown

▶ See the *Surface Materials Reference Guide* at [www.kimball.com](http://www.kimball.com) for a complete overview of the Kimball materials program, including:

- Characteristics of wood
- Special wood finishes
- Customer-specified laminate (CSL)
- Customer-specified paint (CSP)
- Fabric application and colorways
- Customer's own material (COM) overview
- Alliance program
- TB133 process



Statement of Line	▶ See page PD.2
Planning	PD.3
Pricing	PD.5
Surface Materials	PD.7

*Applies to:*

- KORE markerboard marker/eraser holder

**Group 1**

- 480 Antique White
- 427 Barley
- 437 Cement
- 403 Chamois
- 462 Cinder
- 440 Cloud
- 485 Dark Chocolate
- 405 Designer White
- 453 Environmental Grey
- 459 Featherstone
- 450 Fog
- 488 Frosty White
- 461 Graphite
- 445 Moon Beam
- 416 Putty
- 420 Sandstone
- 425 Shadow
- 465 Smoke
- 460 Storm
- 429 Tantalum
- 419 Wallaby

**Group 21**

- 10% upcharge*
- 111 Apricot Orange
  - 103 Chive
  - 106 Cloud Blue
  - 107 Dark Blue
  - 102 Drizzle
  - 109 Fossil
  - 113 Golden Rod
  - 456 Granite
  - 110 Silver Mink
  - 105 Spinach Green
  - 112 Tango Red

**Group M**

- 10% upcharge*
- 514 Carbon Metallic
  - 507 Patina Metallic
  - 501 Platinum Metallic
  - 505 Satin Bronze Metallic
  - 544 Silver Pearl
  - 504 Taupe Metallic

▶ See the *Surface Materials*

- Reference Guide* at [www.kimball.com](http://www.kimball.com) for a complete overview of the Kimball materials program, including:
- Characteristics of wood
  - Special wood finishes
  - Customer-specified laminate (CSL)
  - Customer-specified paint (CSP)
  - Fabric application and colorways
  - Customer's own material (COM) overview
  - Alliance program
  - TB133 process

IMPORTANT: Due to the reflective qualities of metallic paint, variations in color may occur.

# PARADOLIA™ SCREENS & SUSPENSION PANELS

## Notes

Statement of Line	▶ See page PD.2
Planning	PD.3
Pricing	PD.5
Surface Materials	PD.7